

Датчики уровня Soliphant II FTM30(D/S)/31(D/S)/32(D/S)

Техническая информация

По вопросам продаж и поддержки обращайтесь:

Алматы (7273)495-231
Ангарск (3955)60-70-56
Архангельск (8182)63-90-72
Астрахань (8512)99-46-04
Барнаул (3852)73-04-60
Белгород (4722)40-23-64
Благовещенск (4162)22-76-07
Брянск (4832)59-03-52
Владивосток (423)249-28-31
Владикавказ (8672)28-90-48
Владимир (4922)49-43-18
Волгоград (844)278-03-48
Вологда (8172)26-41-59
Воронеж (473)204-51-73
Екатеринбург (343)384-55-89

Иваново (4932)77-34-06
Ижевск (3412)26-03-58
Иркутск (395)279-98-46
Казань (843)206-01-48
Калининград (4012)72-03-81
Калуга (4842)92-23-67
Кемерово (3842)65-04-62
Киров (8332)68-02-04
Коломна (4966)23-41-49
Кострома (4942)77-07-48
Краснодар (861)203-40-90
Красноярск (391)204-63-61
Курск (4712)77-13-04
Курган (3522)50-90-47
Липецк (4742)52-20-81

Магнитогорск (3519)55-03-13
Москва (495)268-04-70
Мурманск (8152)59-64-93
Набережные Челны (8552)20-53-41
Нижний Новгород (831)429-08-12
Новокузнецк (3843)20-46-81
Ноябрьск (3496)41-32-12
Новосибирск (383)227-86-73
Омск (3812)21-46-40
Орел (4862)44-53-42
Оренбург (3532)37-68-04
Краснодар (861)203-40-90
Пенза (8412)22-31-16
Петрозаводск (8142)55-98-37
Псков (8112)59-10-37
Пермь (342)205-81-47

Ростов-на-Дону (863)308-18-15
Рязань (4912)46-61-64
Самара (846)206-03-16
Санкт-Петербург (812)309-46-40
Саратов (845)249-38-78
Севастополь (8692)22-31-93
Саранск (8342)22-96-24
Симферополь (3652)67-13-56
Смоленск (4812)29-41-54
Сочи (862)225-72-31
Ставрополь (8652)20-65-13
Сургут (3462)77-98-35
Сыктывкар (8212)25-95-17
Тамбов (4752)50-40-97
Тверь (4822)63-31-35

Тольятти (8482)63-91-07
Томск (3822)98-41-53
Тула (4872)33-79-87
Тюмень (3452)66-21-18
Ульяновск (8422)24-23-59
Улан-Удэ (3012)59-97-51
Уфа (347)229-48-12
Хабаровск (4212)92-98-04
Чебоксары (8352)28-53-07
Челябинск (351)202-03-61
Череповец (8202)49-02-64
Чита (3022)38-34-83
Якутск (4112)23-90-97
Ярославль (4852)69-52-93

Россия +7(495)268-04-70

Казахстан +7(7172)727-132

Киргизия +996(312)96-26-47

эл.почта: ehr@nt-rt.ru || сайт: <https://endcounters.nt-rt.ru/>



Level



Pressure



Flow



Temperature



Liquid
Analysis



Registration



Systems
Components



Services



Solutions

Technical Information

Soliphant II FTM30(D/S)/31(D/S)/32(D/S)

Level Limit Switch

Universal vibration limit switch for fine-grained bulk solids

Suitable for dust explosion hazardous areas



Application

Soliphant is a rugged limit switch for silos containing powdered or fine-grained solids, including those with very low bulk densities.

The various versions ensure it can be used in a wide range of applications, including dust explosion areas and foodstuffs.

FTM30 (left): compact version for mounting at any orientation; e.g. with aluminium housing (T3) with separate connection compartment

FTM31 (middle): with extension tube max. 4 m for mounting at any orientation; e.g. with aluminium housing (F6)

FTM32 (right): with rope max. 20 m for mounting from above; e.g. with aluminium housing (F6)

Typical applications:

grain, flour, milk powder, cocoa, sugar, animal feed, washing powders, dyes, chalk, plaster, cement, plastic granules

Your Benefits

- No calibration: simple commissioning
- Insensitive to build-up: maintenance-free operation
- No moving parts: no wear, long operating life
- Various electronic inserts: optimum adaptation to the plant control system
- Plastic housing F10 with transparent cover: switching status seen externally, simple control
- Aluminium housing T3 with separate connection compartment: also available with explosion protection to EEx de

Table of contents

Measuring System	3
.....	3
Function	4
.....	4
Summary of Mechanical and Electrical Versions	4
Applications according to certificate	4
Plug-in electronic inserts	5
Housing	5
Process Connections	6
Sensor versions	6
Dimensions	6
.....	6
Installation	8
Soliphant FTM30	8
Soliphant FTM31, FTM32	9
Electrical Connection	10
.....	10
Technical Data	12
General Specifications	12
Application	12
Operation and System Design	12
Input	12
Output	13
Measuring Accuracy	13
Operating Conditions	13
Construction	14
Display and User Interface	15
Power supply	15
Certificates and Approvals	15
Ordering	15
Accessories	16
Seperate Housing HTM10E	16
Rope Shortening Set	16
Protective Hood	16
Sliding Sleeve	17
Product Structure	17
Product Structure	17

Measuring System

Soliphant FTM30/31 or FTM32 with the integrated electronic insert FEM is a compact limit switch to which miniature contactors, magnetic valves and programmable logic controllers (PLCs) can be directly connected. It can be used in safe or in explosion hazardous areas.

Soliphant FTM30D/31D/32D has in addition explosion protection to EEx de.

Soliphant FTM30S/31S/32S has explosion protection to EEx i and requires a separate switching unit Nivotester FTL mounted outside the explosion hazardous area .

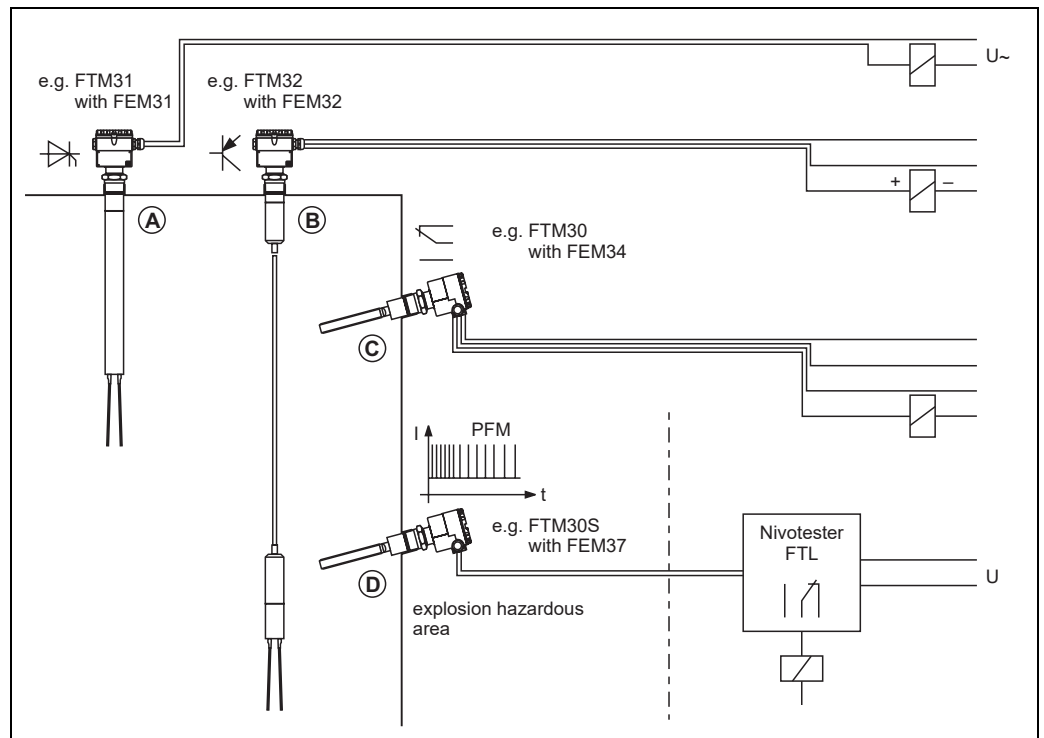

L00-FTM3xxxx-14-05-xx-en-001

















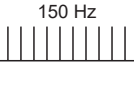



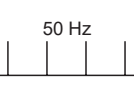



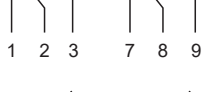

- A) Compact limit switch for two-wire AC power supply
- B) Compact limit switch for three-wire DC power supply
- C) Compact limit switch for universal power supply
- D) Limit switch as intrinsically safe version with remote switching unit

Function

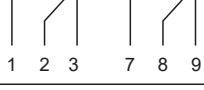
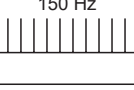
The symmetrical vibrating fork is excited to its resonant frequency. When the fork is covered by material, the vibrations are damped. The change in amplitude is registered by the electronics which activate either an electronic switch or a relay.

Soliphant is especially sensitive at the tip of the fork, making it ideal for the limit detection of materials which have a very low bulk density. In contrast, the base of the fork is very insensitive and is therefore unaffected by material build-up on the vessel walls.

Soliphant can be operated in both minimum or maximum fail-safe mode, i.e. the electronic switch opens or the relay de-energises when the minimum or maximum level is reached, on fault or on power failure.

Level	Fail-safe mode	Electronic inserts				
		FEM31 FEM41	FEM32	FEM34 FEM44	FEM35 FEM45	FEM37
 	Max.					
						
 	Min.					
						
						

L00-FTM3xxxx-05-00-xx-en-001

The function of the electronic switch or relay depends on the level and fail-safe mode.

The electronic insert FEM37 changes the frequency of the PFM signal causing the Nivotester FTL to switch accordingly.

Summary of Mechanical and Electrical Versions

Applications according to certificate

FTM..

- Standard application
- Dust-Ex area

FTM..D

- Standard application
- Gas-Ex area
- Dust-Ex area
- Ignition protection EEx **de**
- CSA, FM: XP

FTM..S

- Standard application
- Dust-Ex area
- Ignition protection EEx **i**
- CSA, FM: IS

Plug-in electronic inserts

simple to replace with another electronic insert
 – without recalibrating –

Two-wire AC power supply (thyristor)

FEM31 for FTM30, FTM30D, FTM31, FTM32;
FEM41 for FTM31D, FTM32D, FTM32 dust-Ex



L00-FTM3xxxx-03-05-xx-xx-001

Three-wire DC power supply (transistor, PNP)

FEM32 for FTM30, FTM30D, FTM31, FTM32
 (not for FTM32 dust-Ex)

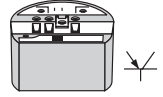

L00-FTM3xxxx-03-05-xx-xx-002

Universal power supply (relay, potential-free changeover contact)

FEM34 for FTM30, FTM30D, FTM31, FTM32;
FEM44 for FTM31D, FTM32D, FTM32 dust-Ex

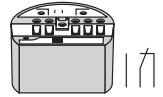

L00-FTM3xxxx-03-05-xx-xx-003

Universal power supply (relay, 2 potential-free changeover contacts)

FEM35 for FTM30, FTM30D, FTM31, FTM32
FEM45 for FTM31D, FTM32D, FTM32 dust-Ex
 (not for EEx de)

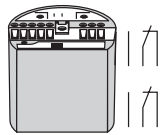

L00-FTM3xxxx-03-05-xx-xx-004

Intrinsically safe signal transmission along two-wire cabling to remote switching unit Nivotester

FEM37 for FTM30S, FTM31S, FTM32S

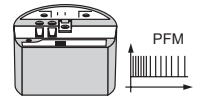

L00-FTM3xxxx-03-05-xx-xx-005

Housing

all with IP66 protection and a wide range of cable entries;
 with high cover for FEM35/45

Aluminium housing **F6**
 for FTM.. and FTM..S

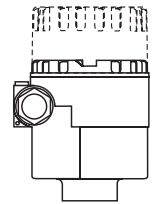

L00-FTM3xxxx-03-05-xx-xx-006

Steel housing **F8**
 for FTM.. and FTM..S

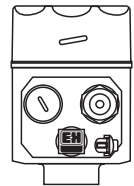

L00-FTM3xxxx-03-05-xx-xx-007

Plastic housing **F10**
 with transparent cover for FTM.. and FTM..S

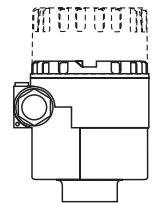

L00-FTM3xxxx-03-05-xx-xx-006

Aluminium housing **T3**
 with separate connection compartment for FTM..D and FTM..S

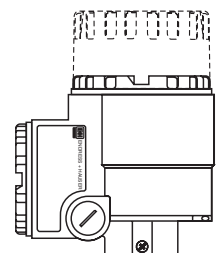

L00-FTM3xxxx-03-05-xx-xx-008

Process Connections

Tapered thread R 1½, DIN 2999
and
Tapered thread 1½ NPT

Various flanges
to DIN/EN, ASME, JIS

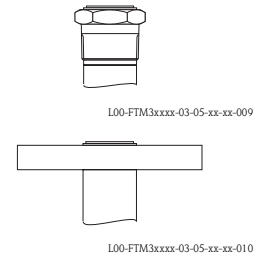

Sensor versions

Vibrating fork in solid stainless steel; resistant to high lateral loads

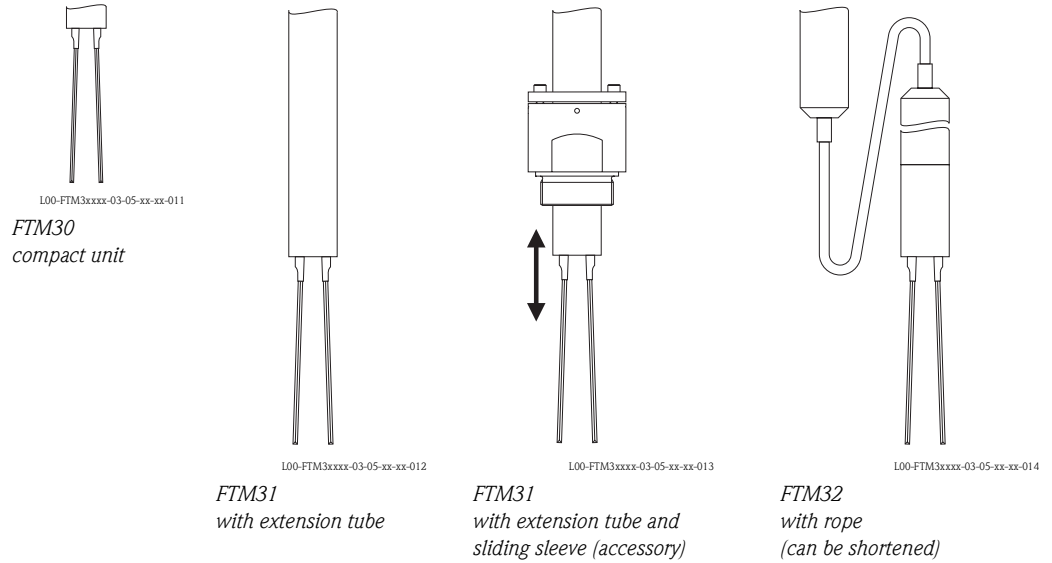

Dimensions

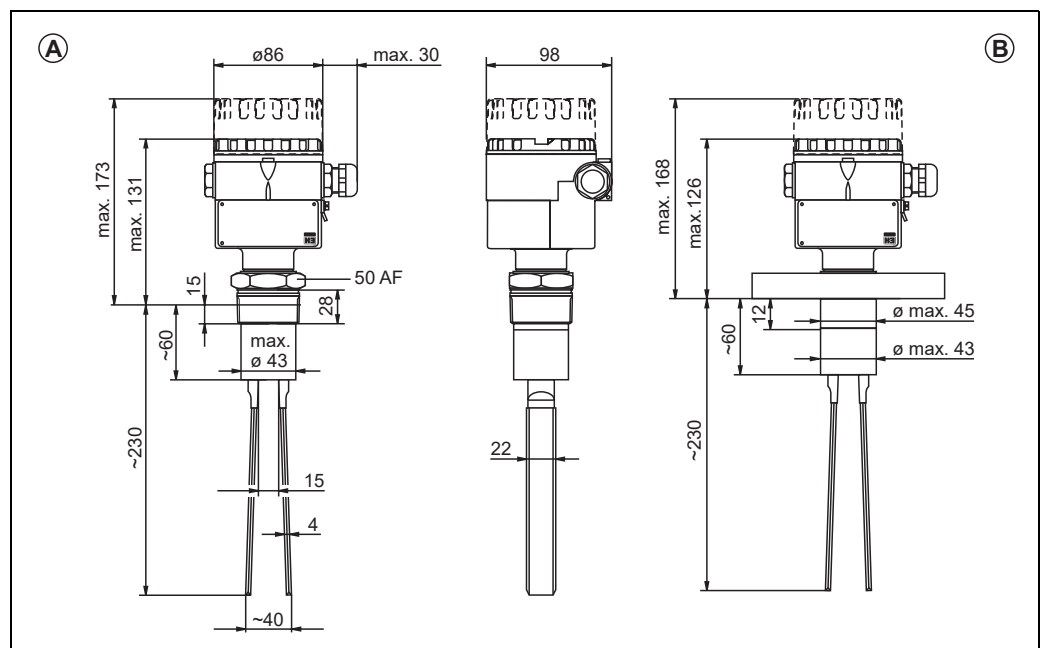

A) FTM30 compact version, with thread R 1½ (DIN 2999) or 1½ NPT, shown with housing F6/F10
B) FTM30 compact version, with flange to EN 1092-1*, ASME B 16.5 or JIS 2210, shown with housing F6/F10

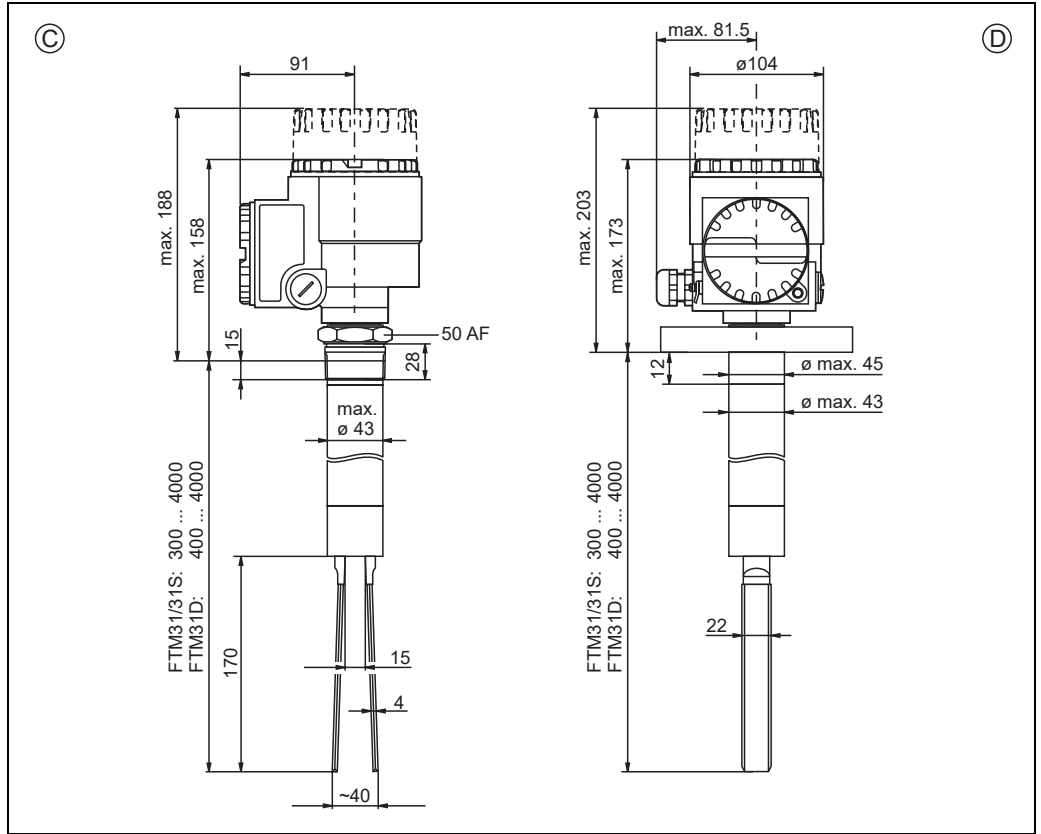

L00-FTM3xxxx-06-05-xx-en-002

C) FTM31 with extension tube, with thread R 1½ (DIN 2999) or 1½ NPT, shown with housing T3

D) FTM31 with extension tube, with flange to EN 1092-1*, ASME B 16.5 or JIS 2210, shown with housing T3

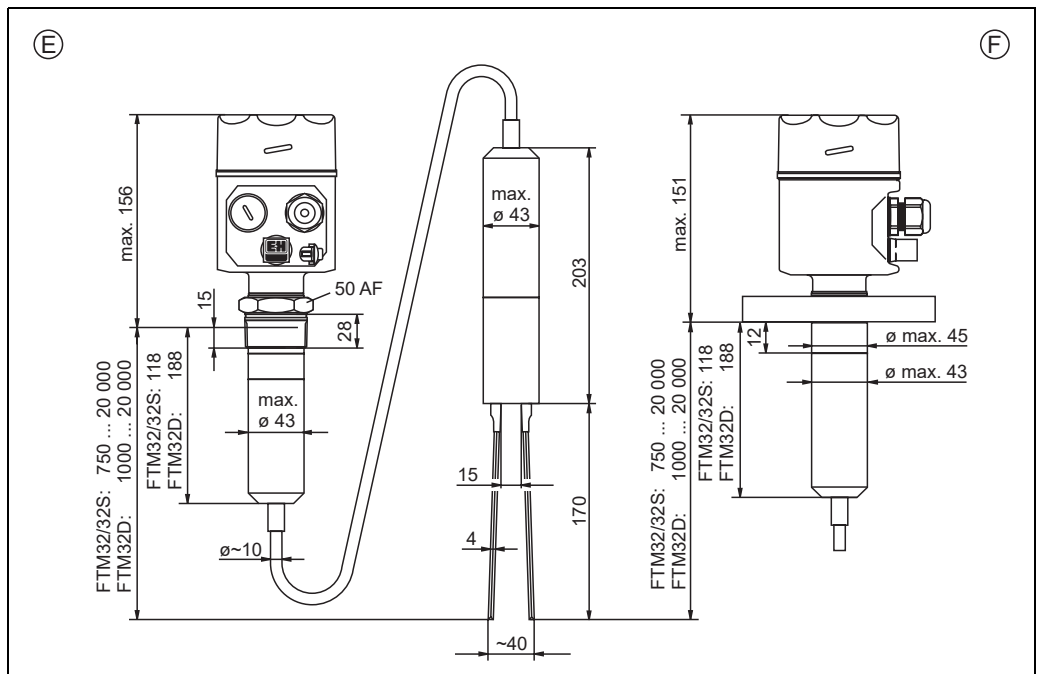

L00-FTM3xxxx-06-05-xx-en-003

E) FTM32 with rope, with thread R 1½ (DIN 2999) or 1½ NPT, shown with housing F8

F) FTM32 with rope, with flange to EN 1092-1*, ASME B 16.5 or JIS 2210, shown with housing F8

* compatibly with DIN 2527 B

Flanges see Page 18, Product Structure: Process Connection and Material.
See data sheets for flange dimensions.

Length tolerances for FTM31

Sensor length	Tolerance
up to 1 m	+0 mm ... -5 mm
up to 3 m	+0 mm ... -10 mm
up to 4 m	+0 mm ... -20 mm

Length tolerances for FTM32

Sensor length	Tolerance
up to 3 m	+2.5 mm ... -15 mm
up to 20 m	+2.5 mm ... -20 mm

Installation

Soliphant FTM30

Take into account the angle of the mound or discharge hopper when determining the height of the installation point.

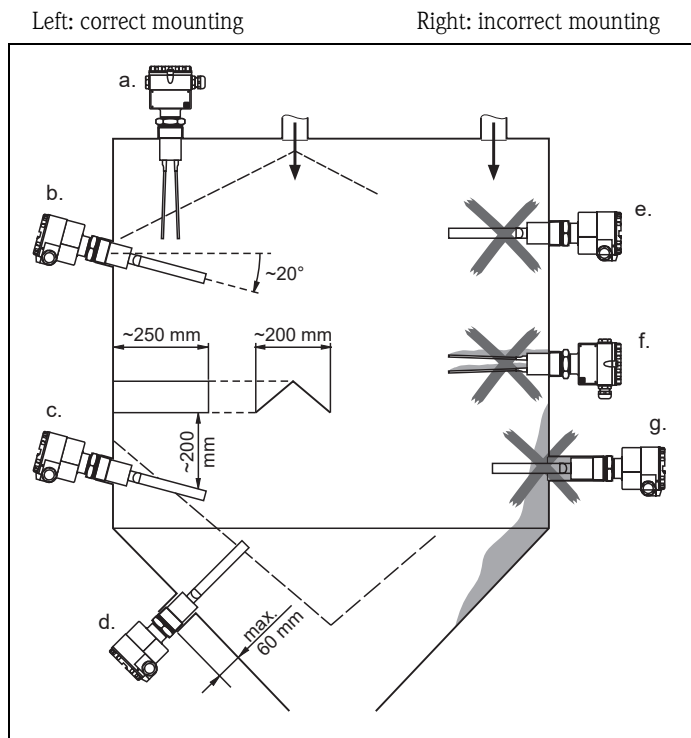

The compact Soliphant version can be mounted at any position in a bulk solids vessel.

Correct mounting:

- top-mounted, tines vertical but at any orientation
- laterally mounted: fork angled slightly downwards so that material can slide off more easily
- with shield: to protect against collapsing mounds (length approx. 250 mm, width approx. 200 mm)
- in discharge hopper. Max. nozzle length 60 mm (2.4 in)

Incorrect mounting:

- in filling curtain
- fork orientation incorrect (broad tine surface is subjected to high load caused by discharging material; malfunction due to residual material)
- mounting nozzle too long

Soliphant FTM31, FTM32

Take into account the angle of the mound or discharge hopper when calculating the length of the sensor required.

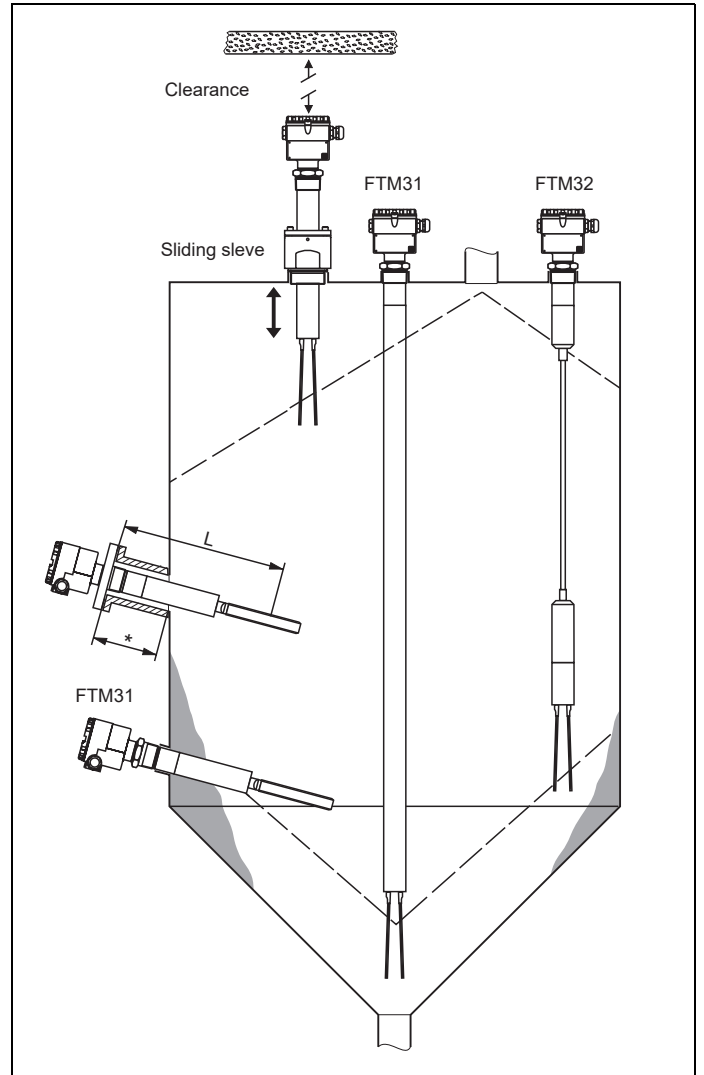

100-FTM3xxxx-11-06-xx-en-001

FTM31 with extension tube

to be used, e.g.

- if mounting is only possible from above
- with heavy build-up on the silo wall
- with sliding sleeve (accessory), if the switch point is to be altered.

Mount in the centre of the discharge hopper in order to keep the lateral load caused by discharging material to a minimum, or close to the vessel wall with an extra fastening near to the fork.

Check that there is enough space outside the silo for mounting.

* Nozzle length:
max. L – 170 mm

FTM32 with rope (can be shortened)

to be used, e.g.

- only top-mounting in a high silo is possible
- there is not enough clearance outside the silo for the long version of the Soliphant FTM31.

The instrument should be installed near to the vessel wall in order to keep the tension caused by discharging material to a minimum. It should not, however, be so near that it touches the wall when it swings.

Electrical Connection

The plug-in electronic inserts can be exchanged without recalibration.
A high housing cover is required for the FEM35/45.

L = LED shows switching status
S = Fail-safe mode is selected using a switch
(with FEM37, on the Nivotester).

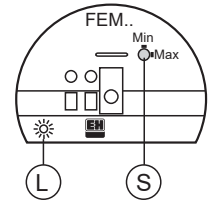

L00-FTM3xxxx-07-05-xx-xx-001



Note!

The diagrams show the direct connection of the electronic insert in the housing F6, F8 or F10.

The terminals in the separate connection compartment of the housing T3 have the same designations as those of the built-in electronic insert.

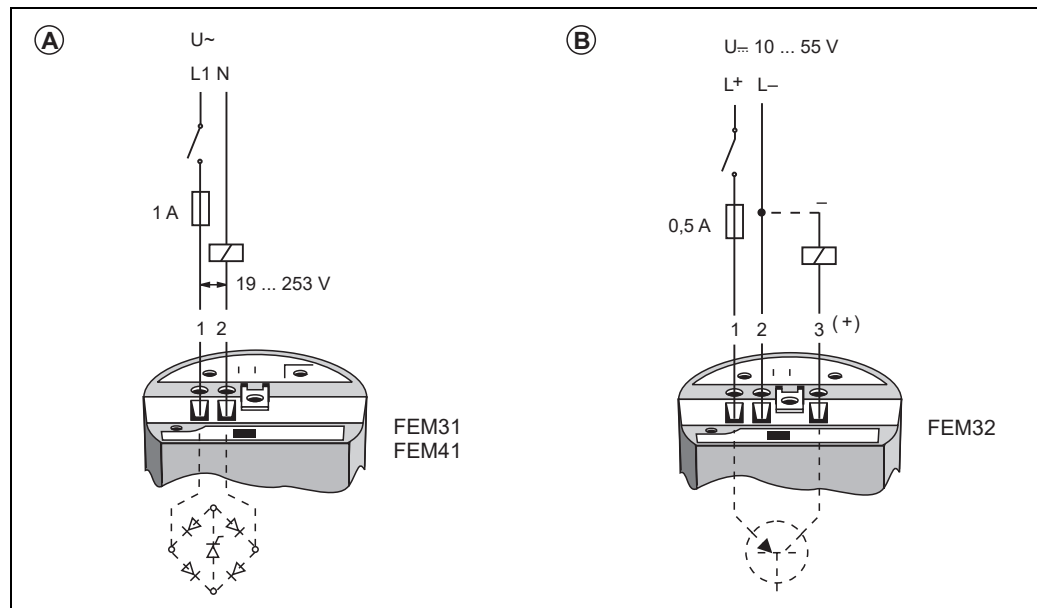

L00-FTM3xxxx-04-05-xx-xx-001

A) Electronic insert FEM31, FEM41

Two-wire AC power supply

Always connect in series with a load!

Note the voltage drop across the electronic insert in the conducting state (max. 12 V), the residual current in the blocked state (max. 4 mA) and, when using low voltages, the voltage drop across the load.

The terminal voltage at the electronic insert must never be less than 19 V!

B) Electronic insert FEM32

Three-wire DC power supply.

Recommended for use with programmable logic controllers (PLC).

Positive signal at the switching output of the electronic insert (PNP).

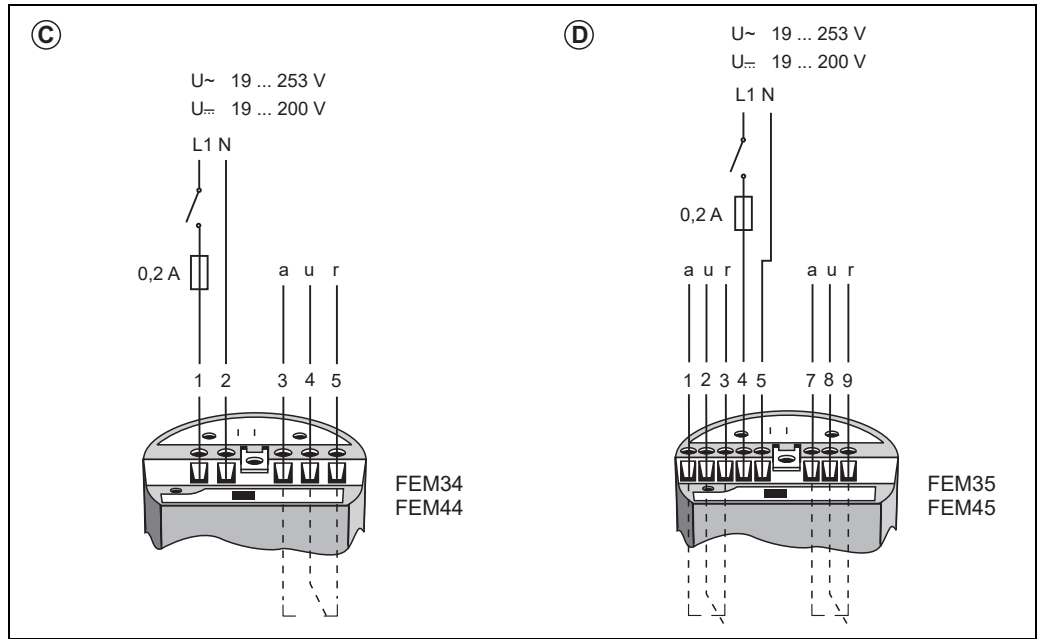

L00-FTM3xxxx-04-05-xx-xx-002

C) Electronic insert FEM34, FEM44

Universal power supply with relay output
1 potential-free changeover contact (SPDT) *

D) Electronic insert FEM35, FEM45

Universal power supply with relay output
2 potential-free changeover contacts (DPDT) *

* When connecting a low-voltage circuit with double isolation according to IEC 1010 the following applies:
Voltage sum of power supply and relay output max. 300 V.

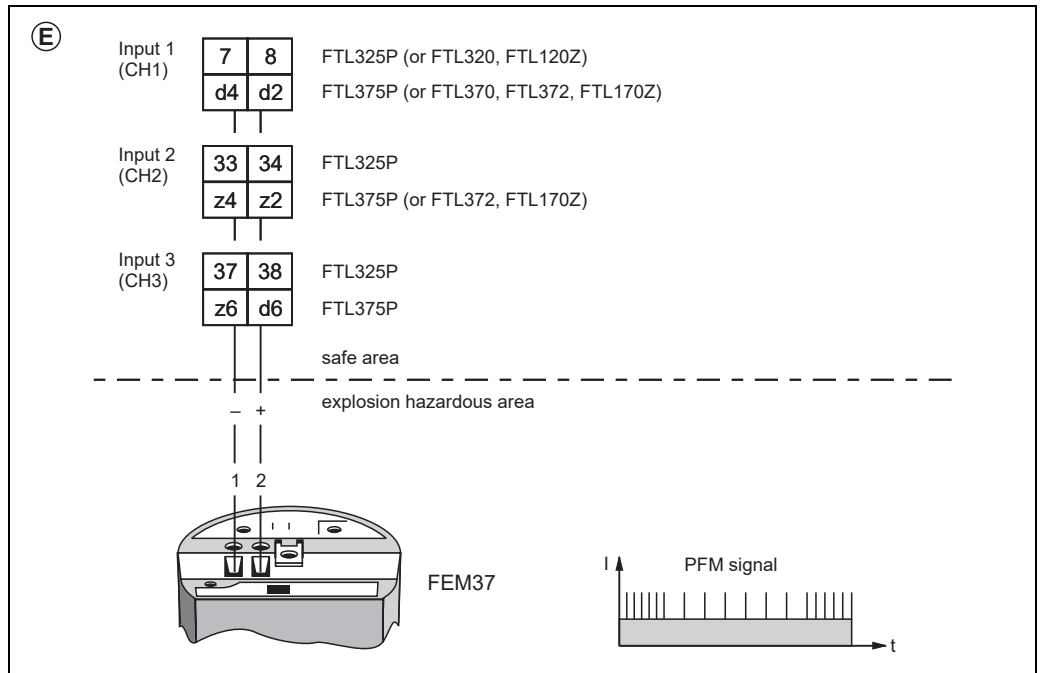

L00-FTM3xxxx-04-05-xx-en-001

E) Electronic insert FEM37

Intrinsically-safe PFM signal transmission along two-wire cabling to the remote switching unit Nivotester FTL325 or FTL375.
(Can also be connected to the earlier types FTL120Z, FTL170Z, FTL320, FTL370 or FTL372).

Technical Data

General Specifications	<p>Instrument family: Soliphant II</p> <p>Instrument types: FTM30, FTM31, FTM32 FTM30D, FTM31D, FTM32D FTM30S, FTM31S, FTM32S</p> <p>Instrument function: Level limit switch</p>
Application	<p>Limit detection: Maximum or minimum detection in silos with powdery and fine-grained solids, max. grain size 10 mm</p>
Operation and System Design	<p>Measuring principle: Damping of the oscillation of a fork vibrating at its resonant frequency</p> <p>Modularity:</p> <ul style="list-style-type: none"> - FTM.. and FTM..D: complete limit switch, consisting of the sensor with the integrated electronic insert FEM.. (switching unit); - FTM..S: sensor with integrated electronic insert FEM37 (transmitter) for connection to remote switching unit Nivotester FTL... <p>Signal processing:</p> <ul style="list-style-type: none"> - Two-wire AC version (with FEM31/41): load switched directly via a thyristor in the power supply; - Three-wire version (with FEM32): load switched via a transistor and separate connection; - Universal version with relay output (with FEM34/44/35/45): load switched via a potential-free changeover contact; - Version for remote switching unit (with FEM37): PFM signal transmission; current pulses superimposed on the current flowing in the two-wire power cabling <p>Electrical isolation:</p> <ul style="list-style-type: none"> - With FEM31/32/41: between sensor and power supply; - With FEM34/44/35/45: between sensor and power supply and load; - With FEM37: between sensor and power supply, in remote switching unit Nivotester between power supply and load
Input	<p>Measured variable: Height (limit value, binary)</p> <p>Measuring range (detection range):</p> <ul style="list-style-type: none"> - FTM30: determined by installation point - FTM31: determined by sensor length (pipe) (approx. 300 ... 4000 mm from above, FTM31D: approx. 400 ... 4000 mm) - FTM31 with sliding sleeve: adjustable approx. 200 ... 3900 mm from above - FTM32: determined by sensor length (rope) (approx. 800 ... 20000 mm from above, FTM32D: approx. 1000 ... 20000 mm)

Output	<p>Output signal: Binary; output blocked on reaching limit</p> <p>Signal failure: Output blocked</p> <p>Load (connectable) with FEM31/41 (AC, load switched via thyristor directly in the power supply): Transient (40 ms) max. 1.5 A, max. 375 VA at 253 V or max. 36 VA at 24 V (no short circuit-protection) continuous max. 87 VA at 253 V, max. 8.4 VA at 24 V min. 2.5 VA at 253 V (10 mA), min. 0.5 VA at 24 V (20 mA) Voltage drop across FEM.. max. 12 V Residual current max. 4 mA with blocked thyristor</p> <p>Load (connectable) with FEM32 (DC, load switched via transistor and separate PNP connection): Transient (1 s) max. 1 A, max. 55 V (cyclic protection against overload and short circuiting); continuous max. 350 mA, max. 55 V; max. 0.5 μF at 55 V, max. 1.0 μF at 24V; Residual voltage < 3 V (with conducting transistor); Residual current < 100 μA (with blocked transistor)</p> <p>Load (connectable) with FEM34/44/35/45 (Universal current, load switched via potential-free changeover contact): FEM34/44: 1 potential-free changeover contact (SPDT), FEM35/45: 2 potential-free changeover contacts (DPDT) I~ max. 6 A, U~ max. 253 V; P~ max.1500 VA, cos φ = 1, P~ max. 750 VA, cos φ > 0.7; I= max. 6 A to 30 V, I= max. 0.2 A to 125 V;</p> <p>Load (connectable) with FEM37 (potential-free relay contact in switching unit Nivotester FTL): See Technical Data of the switching unit Nivotester FTL320, FTL370, FTL372, (FTL120Z, FTL170Z), FTL325P, FTL375P</p> <p>Output, General Information</p> <p>Fail-safe switching: Minimum or maximum fail-safe mode, switchable</p> <p>Switching time: – FEM31/32/34/41/44: Approx. 0.5 s when covered, approx. 1.5 s when free – FEM35/45: Approx. 0.5 s when covered, approx. 1.5 s when free, switchable to approx. 2.5 s when covered, approx. 7.5 s when free</p>
Measuring Accuracy	<p>Reference conditions: Temperature T = 20 °C, operating pressure p_e = 1 bar, Density of material > 1 kg/l, grain size < 2 mm</p> <p>Measured error: Approx. 10 mm for vertical mounting, 5 mm for lateral mounting of the sensor</p> <p>Settling time: The output remains open approx. 2.5 s after switching on the power supply</p> <p>Switching time error: +/- 25 % when covered or uncovered</p> <p>Effects of temperature and operating pressure: Negligible</p>
Operating Conditions	<p>Mounting</p> <p>Orientation: Any position for FTM30 and FTM31 with short tube Vertical for FTM31 with long tube and FTM32</p>

Lateral load on fork for FTM30:
600 N (on narrow edge of tines), static

Lateral load on tube for FTM31:
300 Nm (max. 1 m)

Tensile strength of rope for FTM32:
2500 N

Environment

Operating temperature range:
-40 °C ... +70 °C

Storage temperature range:
-40 °C ... +85 °C

Climatic class:
Climatic protection to IEC 68, Part 2-38, Fig. 2a

Ingress protection (housing)
IP66 to DIN 40050

Electromagnetic compatibility:

- FEM31/32/34/41/44:

Interference Emission to EN 61326, Electrical Equipment Class B

Interference Immunity to EN 61326, Annex A (Industrial) and NAMUR Recommendation NE 21 (EMC)

- FEM35/45:

Interference Emission to EN 61326, Electrical Equipment Class A

Interference Immunity to EN 61326, Annex A (Industrial) and NAMUR Recommendation NE 21 (EMC)

Product

Temperature of product:
-40 °C ... +150 °C, see also graphs on page 16

Pressure (operating pressure) p_e :
-1 bar ... max. 16 bar (FTM30/31), 6 bar (FTM32D), 2 bar (FTM32)

Pressure limit:
Burst pressure min. 100 bar (FTM30/31), 40 bar (FTM32D), 3 bar (FTM32)

Density of product:
min. 20 g/l

Grain size of product:
max. 10 mm

Construction

Design:
- FTM30: compact unit
- FTM31: with extension tube max. 4 m
- FTM32: with rope max. 20 m

Dimensions:
See dimensioned drawings on Pages 6 and 7

Weight:
See Product Structure on Pages 17, 18 and 19

Materials:

Process connection (thread): stainless steel AISI 304 (1.4301);

Flanges: AISI 316Ti (1.4571), tube: AISI 304 (1.4301), rope insulation: PUR

Vibrating fork: stainless steel AISI 316Ti (1.4571);

Housing F10: fibre-glass reinforced polyester (blue);

Low transparent cover: polyamide; high transparent cover: polycarbonat

Housing F6, T3: aluminium GD-Al 10, DIN 1725, with plastic coating;

Housing F8: stainless steel AISI 316L (1.4404);

Seal for housing cover F6, T3: EPDM (elastomer),
for housing cover F8, F10: silicone;

Cable gland Pg 13.5: polyamide with NBR seal

Cable gland Pg 16: polyamide with neoprene-CR seal

Process connections:

Tapered thread R 1½ to DIN 2999 Part 1;

Tapered thread 1½ NPT to ASME B 1.20.1

Flanges to DIN, ASME, JIS see Product Structure.

Electrical connection:

Terminal screws on electronic insert for max. 2.5 mm² conductor in A 2.5 - 7 sleeves to DIN 46228;

Terminal screws in separate connection compartment of housing T3: for max. 2.5 mm² conductor in A 2.5 - 7 sleeves to DIN 46228

Display and User Interface

On electronic insert FEM31/32/34/35/41/44/45:

Rotary switch for minimum/maximum fail-safe;
red LED showing switching status

On electronic insert FEM37:

Green LED showing status for cover

Power supply

Electronic insert FEM31/41:

Voltage at Terminal 1 and 2: 19 ... 253 V, 50 / 60 Hz;

Current consumption (stand-by) max. 4 mA

Electronic insert FEM32:

10 ... 55 V, ripple max. 1.7 V, 0 ... 400 Hz;

current consumption max. 15 mA, reverse polarity protection

Electronic insert FEM34/44/35/45:

AC voltage 19 ... 253 V, 16 ... 60 Hz or DC voltage 19 ... 200 V;

– current consumption FEM34/44: max. 7 mA

– current consumption FEM35/45: max. 10 mA

Electronic insert FEM37:

powered by the switching unit Nivotester FTL

Certificates and Approvals

ATEX, FM, CSA, TIIS:

See Product Structure on Pages 17/18

Ordering

Product designation:

See Product Structure on Page 19

Accessories:

See pages 16/17

Supplementary documentation:

– General information on EMC

TI 241F/00/en

– Technical Information to separate housing HTM10E

TI 274F/00/en

– Safety instructions for FTM3#-B (ATEX II 1/3 D)

XA 023F/00/a3

– Safety instructions for FTM3#S-Z (ATEX II 1/2 GD)

XA 001F/00/a3

– Safety instructions for FTM3#S-Z + HTM10E (ATEX II 1/2 GD)

XA 051F/00/a3

– Safety instructions for FTM30/31D-H (ATEX II 2 G, II 1/3 D)

XA 066F/00/a3

– Safety instructions for FTM32D-X (ATEX II 2 G, II 1/3 D)

XA 066F/00/a3

– Safety instructions for FTM30/31D-1 (ATEX II 2 G, II 1 D)

XA 066F/00/a3

– Safety instructions for FTM32D-2 (ATEX II 2 G, II 1 D)

XA 066F/00/a3

– Safety instructions for FTM30/31D-3 (ATEX II 1/2 G)

XA 066F/00/a3

Certificates:

On request

Permissible ambient temperature values T_U at the housing as a function of the operating temperature T_B in the silo:

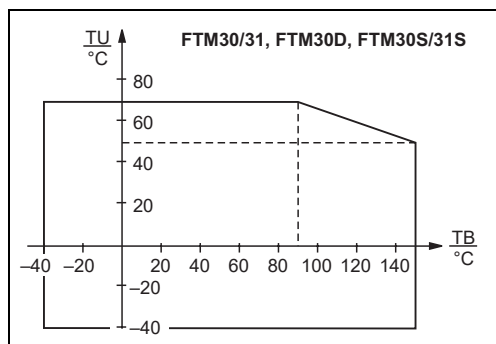

L00-FTM3xxxx-05-06-xx-xx-001

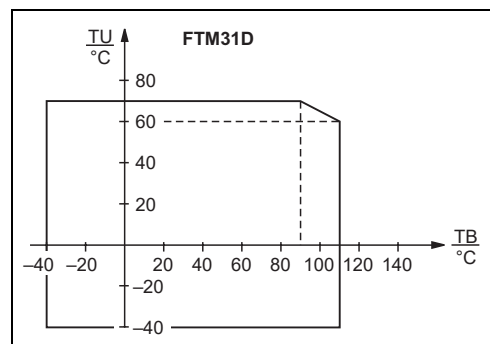

L00-FTM3xxxx-05-06-xx-xx-002

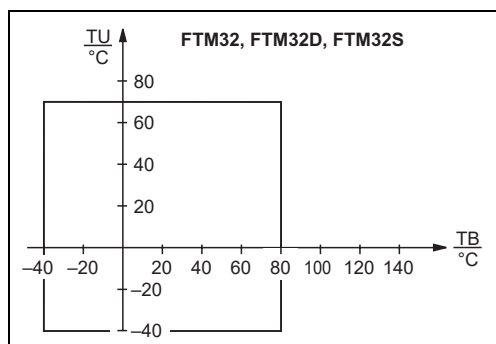

L00-FTM3xxxx-05-06-xx-xx-003

Accessories

Separate Housing HTM10E

for the electronic insert of Soliphant.

Easier operation when the Soliphant is mounted in a confined space and wider ambient temperature range for the Soliphant housing.

See Technical Information TI 274F/00/en.

Rope Shortening Set

for Soliphant FTM32.

This consists of a number of accessories which enable the rope to be shortened and make a permanent and water-tight connection with the sensor.

Instructions for mounting are included.

Order-No.: 935 622-0001.

FTM32 with standard lengths 2500 mm or 6000 mm: The rope shortening set is enclosed.

Protective Hood

Protects the field-mounted Soliphant from excessive temperatures caused by direct sunlight and prevents condensation from entering the housing due to extreme temperature variations.

For housings F6, F10

– Material: polyamide

For low housing cover:

– Weight: 0.13 kg

– Order-No.: 942 262-0000

For high housing cover:

– Weight: 0.16 kg

– Order-No.: 942 262-0001

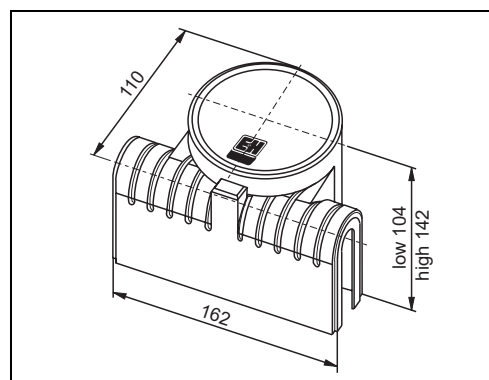

L00-FTM3xxxx-03-05-xx-xx-001

Sliding Sleeve

When mounting the Solphant FTM31 in the silo from above, the sliding sleeve allows the switch point to be infinitely adjusted.

- Maximum permissible operating pressure: 16 bar;
- Max. operating temperature: 150 °C;
- Material: stainless steel 1.4301 (AISI 304);
- Packing for threaded gland: Graphite;
- Weight: 1.79 kg

With thread G 2 A
 - Order-No.: 943 090-1002

With thread 2-11½ NPT
 - Order-No.: 943 090-1102

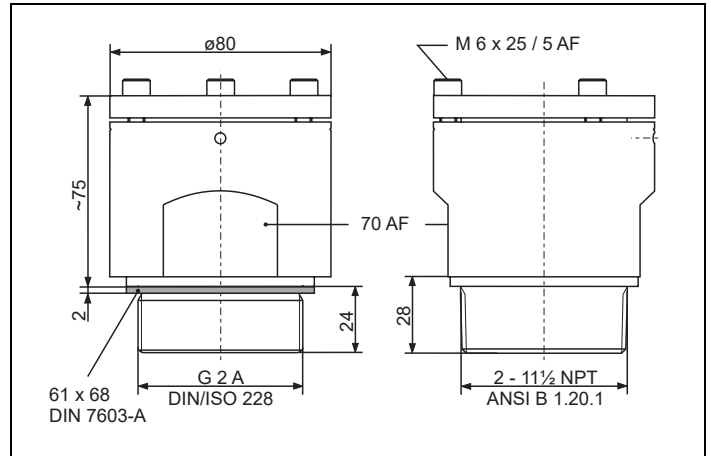

L00-FTM3xxxx-06-05-xx-en-004

Product Structure

Product Structure

Construction		Basic Weight
For standard applications and dust explosion hazardous area		
FTM30	compact version	1.3 kg
FTM31	with extension tube	1.2 kg
FTM32	with rope	2.9 kg
For standard applications and dust explosion hazardous area and Ex area Zone 1; ignition protection EEx de		
FTM30D	compact version	2.3 kg
FTM31D	with extension tube	2.2 kg
FTM32D	with rope	4.0 kg
For standard applications and dust explosion hazardous area and explosion hazardous area Zone 1; ignition protection EEx i		
FTM30S	compact version	1.3 kg
FTM31S	with extension tube	1.2 kg
FTM32S	with rope	2.9 kg

10	Certificates, Applications
A	For non-hazardous area use
For FTM30/31/32	
B	ATEX II 1/3 D
D	CSA DIP Cl. II, Div. 1, Gr. E-G, Cl. III (FTM30/31)
E	CSA DIP Cl. II, Div. 1, Gr. G+coal dust (FTM32)
F	FM DIP Cl. II, Div. 1, Gr. E-G, Cl. III
4	ATEX II 3 D
5	ATEX II 3 G EEx nA II T6
6	ATEX II 3 G EEx nC II T6
For FTM30D/31D/32D	
G	FM XP Cl. I, II, Div. 1, Gr. A-G, Cl. III
H	ATEX II 1/3 D, ATEX II 2 G EEx de IIC T6
J	TIIS (Ex d) labeling in Japan
K	CSA XP Cl. I, II, Div. 1, Gr. A-G, Cl. III (FTM30D)
L	CSA XP Cl. I, Div. 1, Gr. B+D, Cl. II, Div. 1, Gr. G+coal dust, Cl. III (FTM32D)
M	CSA XP Cl. I, II, Div. 1, Gr. B-G, Cl. III (FTM31D)
Q	FM XP Cl. I, II, Div. 1, Gr. C-G, Cl. III (FTM32D)
X	ATEX II 1/3 D, ATEX II 2 G EEx de IIB T6 (FTM32D)
1	ATEX II 1 D, ATEX II 2 G EEx de IIC T6 (FTM30D/31D)
2	ATEX II 1 D, ATEX II 2 G EEx de IIB T6 (FTM32D)
3	ATEX II 1/2 G EEx de IIC T6 (FTM30D/31D)

10		Certificates, Applications			
For FTM30S/31S/32S					
N	ATEX II 1/2 D, ATEX II 1/2 G	EEx ia IIC T6			
P	FM IS	Cl. I, II, Div. 1, Gr. A-G, Cl. III			
S	TIIS (Ex ia)	labeling in Japan			
T	CSA IS	Cl. I, II, Div. 1, Gr. A-G, Cl. III	(FTM30S/31S)		
U	FM IS	Cl. I, II, Div. 1, Gr. C-G, Cl. III	(FTM32S)		
W	CSA IS	Cl. I, Div. 1, Gr. C+D, Cl. II, Div. 1, Gr. G+coal dust, Cl. III	(FTM32S)		
Z	ATEX II 1/2 D, ATEX II 1/2 G	Ex ia IIB T6			
Y	Special version				
20		Electronics			Additional Weight
1	Two-wire, contactless, for FTM30/31/32, FTM30D/31D/32D		19...253 V AC;		
2	Three-wire, PNP, for FTM30/31/32, FTM30D	FEM32	10...55 V DC		
4	Relay SPDT, for FTM30/31/32, FTM30D/31D/32D		19...253 V AC; 19...200 V DC		
5	Relay DPDT, for FTM30/31/32, FTM30D/31D/32D		19...253 V AC; 19...200 V DC	0,1 kg	
7	Two-wire PFM transmission, for FTM30S/31S/32S	FEM37			
8	Electronic insert not selected for FTM30/31/32			-0,2 kg	
9	Special version				
30		Housing and cable entry			
For FTM30/31/32 and FTM30S/31S/32S					
B	Aluminium	F6	NPT 1/2" entry	IP66	0,2 kg
C	Aluminium	F6	G 1/2 A entry	IP66	0,2 kg
D	Aluminium	F6	M20 gland	IP66	0,2 kg
F	Polyester	F10	NPT 1/2" entry	IP66	
G	Polyester	F10	G 1/2 A entry	IP66	
H	Polyester	F10	M20 gland	IP66	
2	316L	F8	G 1/2 A entry	IP66	0,4 kg
3	316L	F8	M20 gland	IP66	0,4 kg
4	316L	F8	NPT 1/2" entry	IP66	0,4 kg
For FTM30D/31D/32D and FTM30S/31S/32S					
K	Aluminium	T3	NPT 3/4" entry	IP66	0,1 kg
L	Aluminium	T3	G 1/2 A entry	IP66	0,1 kg
M	Aluminium	T3	M20 gland	IP66	0,1 kg
Y	Special version				
40		Process connection, material			
A	R 1 1/2			304	
B	1 1/2" NPT			304	
H	DN 50	PN 25/40 A	EN 1092-1 (DIN 2527 B)	316Ti	3,0 kg
J	DN 80	PN 10/16 A	EN 1092-1 (DIN 2527 B)	316Ti	4,5 kg
K	DN 100	PN 10/16 A	EN 1092-1 (DIN 2527 B)	316Ti	5,4 kg
M	2"	150 lbs	RF ASME B16.5	316Ti	1,6 kg
N	4"	150 lbs	RF ASME B16.5	316Ti	5,4 kg
P	3"	150 lbs	RF ASME B16.5	316Ti	3,7 kg
1	10K 50A		RF JIS B2210	316Ti	2,0 kg
2	10K 80A		RF JIS B2210	316Ti	3,0 kg
3	10K 100A		RF JIS B2210	316Ti	4,0 kg
Y	Special version				
50		Additional option			
1	Basic version				
9	Special version				

60						Probe length	
						For FTM31, FTM31D, FTM31S	
						A mm (300...4000 mm) (FTM31, FTM31S only) 2,0 kg/m
						B	500 mm 1,0 kg
						C	1000 mm 2,0 kg
						D mm (400...4000 mm) (FTM31D only) 2,0 kg/m
						1 in (12...155 in) (FTM31, FTM31S only)
						3 in (16...155 in) (FTM31D only)
						For FTM32, FTM32D, FTM32S	
						J mm (750...20000 mm) (FTM32, FTM32S only) 0,1 kg/m
						K	2500 mm 0,3 kg
						L	6000 mm 0,7 kg
						M mm (1000...20000 mm) (FTM32D only) 0,1 kg/m
						2 in (30...790 in) (FTM32, FTM32S only)
						4 in (40...790 in) (FTM32D only)
						7	100 in
						8	240 in
						Y	Special version
FTM30-							
FTM30D-							complete product designation
FTM30S-							
FTM31/32-							
FTM31D/32D-							complete product designation
FTM31S/32S-							



Note!

Basic Weight::

- without extension tube
- without rope
- with threaded boss
- with electronic insert
- with plastic housing F10 for FTM.. and FTM..S
- with aluminium housing T3 for FTM..D

По вопросам продаж и поддержки обращайтесь:

Алматы (7273)495-231
Ангарск (3955)60-70-56
Архангельск (8182)63-90-72
Астрахань (8512)99-46-04
Барнаул (3852)73-04-60
Белгород (4722)40-23-64
Благовещенск (4162)22-76-07
Брянск (4832)59-03-52
Владивосток (423)249-28-31
Владикавказ (8672)28-90-48
Владимир (4922)49-43-18
Волгоград (844)278-03-48
Вологда (8172)26-41-59
Воронеж (473)204-51-73
Екатеринбург (343)384-55-89

Иваново (4932)77-34-06
Ижевск (3412)26-03-58
Иркутск (395)279-98-46
Казань (843)206-01-48
Калининград (4012)72-03-81
Калуга (4842)92-23-67
Кемерово (3842)65-04-62
Киров (8332)68-02-04
Коломна (4966)23-41-49
Кострома (4942)77-07-48
Краснодар (861)203-40-90
Красноярск (391)204-63-61
Курск (4712)77-13-04
Курган (3522)50-90-47
Липецк (4742)52-20-81

Магнитогорск (3519)55-03-13
Москва (495)268-04-70
Мурманск (8152)59-64-93
Набережные Челны (8552)20-53-41
Нижний Новгород (831)429-08-12
Новокузнецк (3843)20-46-81
Ноябрьск (3496)41-32-12
Новосибирск (383)227-86-73
Омск (3812)21-46-40
Орел (4862)44-53-42
Оренбург (3532)37-68-04
Пенза (8412)22-31-16
Петрозаводск (8142)55-98-37
Псков (8112)59-10-37
Пермь (342)205-81-47

Ростов-на-Дону (863)308-18-15
Рязань (4912)46-61-64
Самара (846)206-03-16
Санкт-Петербург (812)309-46-40
Саратов (845)249-38-78
Севастополь (8692)22-31-93
Ставрополь (8652)22-96-24
Симферополь (3652)67-13-56
Смоленск (4812)29-41-54
Сочи (862)225-72-31
Ставрополь (8652)20-65-13
Сургут (3462)77-98-35
Сыктывкар (8212)25-95-17
Тамбов (4752)50-40-97
Тверь (4822)63-31-35

Тольятти (8482)63-91-07
Томск (3822)98-41-53
Тула (4872)33-79-87
Тюмень (3452)66-21-18
Ульяновск (8422)24-23-59
Улан-Удэ (3012)59-97-51
Уфа (347)229-48-12
Хабаровск (4212)92-98-04
Чебоксары (8352)28-53-07
Челябинск (351)202-03-61
Череповец (8202)49-02-64
Чита (3022)38-34-83
Якутск (4112)23-90-97
Ярославль (4852)69-52-93

Россия +7(495)268-04-70

Казахстан +7(7172)727-132

Киргизия +996(312)96-26-47

эл.почта: ehr@nt-rt.ru || сайт: <https://endcounters.nt-rt.ru/>